

**SINGER**  
**DEARBORN BLIND**  
**STITCH MACHINE**

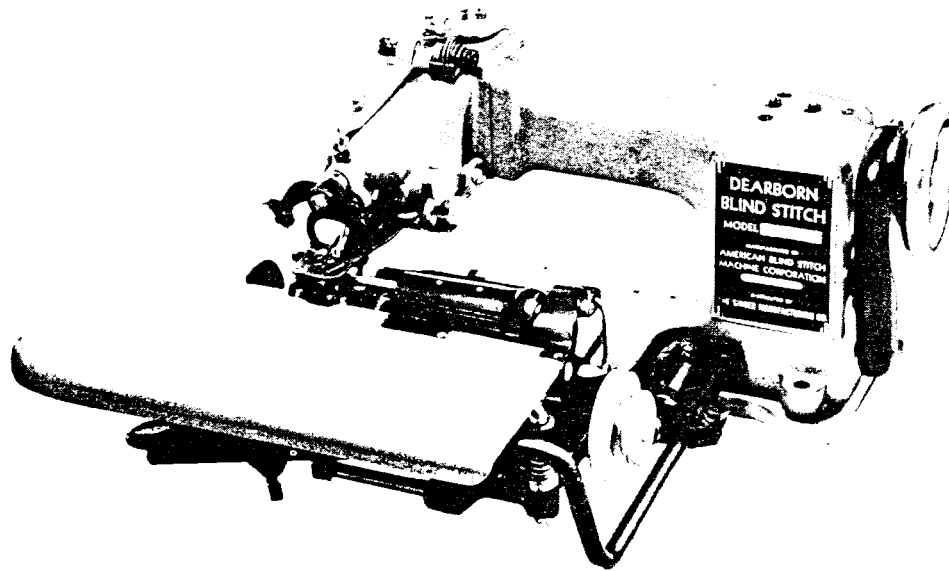

# SINGER\*



From the library of: Diamond Needle Corp

## PARTS LIST

### DEARBORN BLIND STITCH MACHINE MODEL 12 SS-1

#### SECTIONS

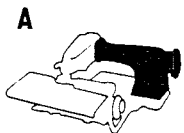

**MAIN SHAFT  
GEAR ASSEMBLY**



**NEEDLE SHAFT  
LOOPER ROD  
NEEDLE ECCEN-  
TRIC**

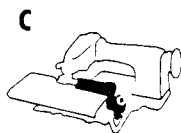

**FEED FRAME  
REGULATING  
DIAL**

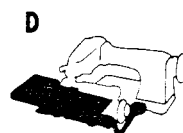

**SWING PLATE  
KNEE LIFT**



**SKIP CONTROL  
AND CRANK**



**MACHINE  
HEAD**

**SINGER COMPANY OF CANADA LIMITED**

# A MAIN SHAFT GEAR ASSEMBLY

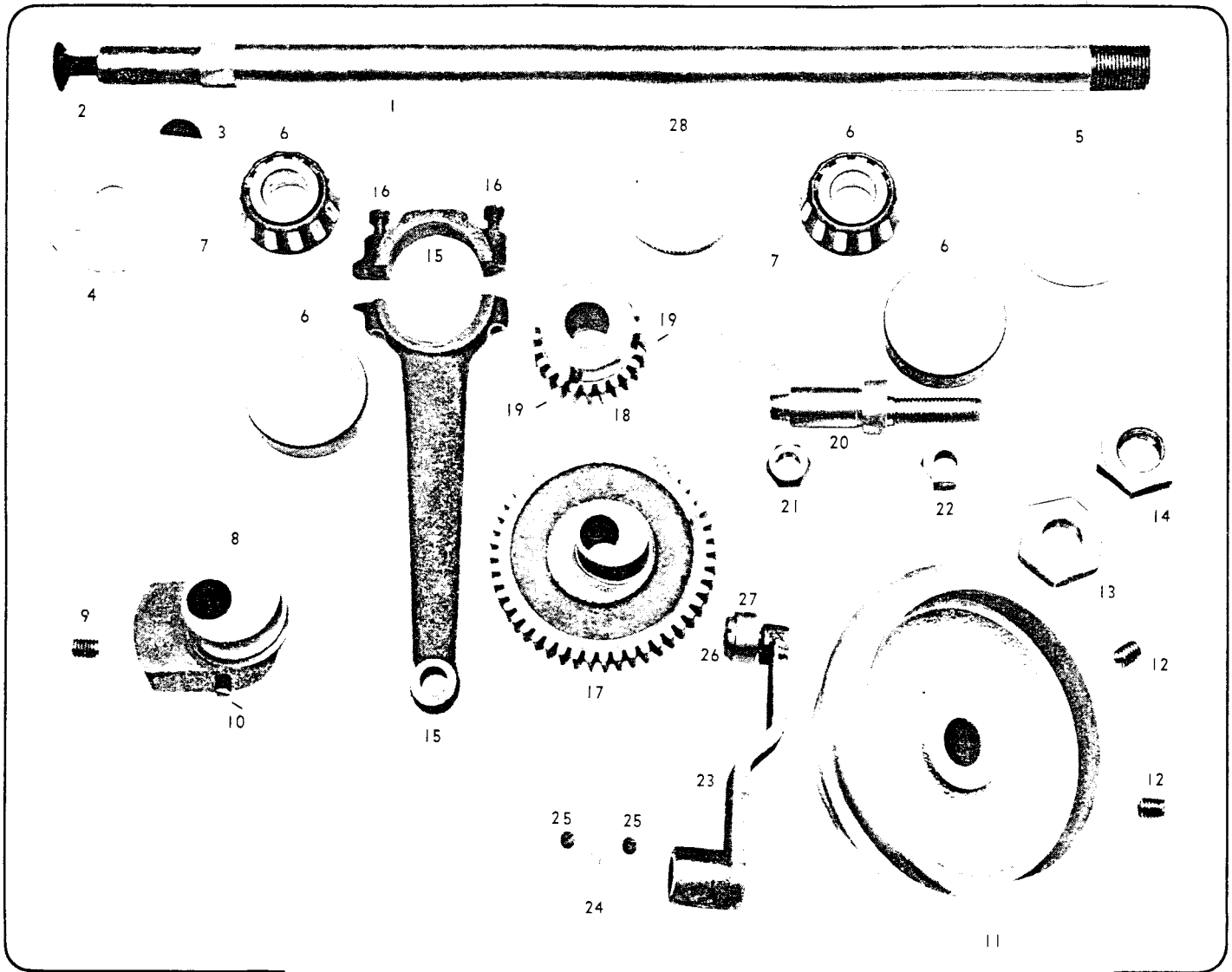

Illustrn. Ref. No.	Part No.	Description	Illustrn. Ref. No.	Part No.	Description
1	400314	Main Shaft	11	400313	Hand Wheel
2	400322	Main Shaft End Screw	12	400098	Hand Wheel Set Screw (2)
3	400321	Needle Stitch Eccentric Woodruff Key	13	400316	Main Shaft Adjusting Nut
4	400317	Roller Bearing Shield — Left	14	402404	Main Shaft Lock Nut
5	400318	Roller Bearing Shield — Right	15	400345	Main Shaft Connection Lever Style 2
6	400315	Roller Bearing Cup & Cone (2 Sets)	16	400094	Main Shaft Connection Lever Clamping Screw
7	402409	Roller Bearing Oil Pad (Felt) (2)	17	402442	Large Gear Skip 1 (2)
8	400340	Main Shaft Connection Lever Eccentric	18	402444	Small Gear Skip 1
9	400098	Main Shaft Connection Lever Eccentric Set Screw	19	401405	Small Gear Set Screw (2)
10	400099	Main Shaft Connection Lever Eccentric Set Screw	20	400354	Large Gear Stud
			21	400355	Large Gear Stud Nut
			22	400357	Large Gear Stud Lock Nut
			23	400359	Cam Lever
			24	400367	Skip Control Cam Crank Tapered Pin
			25	400100	Cam Lever Set Screw
			26	400364	Cam Lever Shaft Roller Stud
			27	400363	Cam Lever Shaft Roller
			28	400319	Roller Bearing Retainer (Aluminum)

# B<sup>1</sup> NEEDLE SHAFT, LOOPER ROD, NEEDLE ECCENTRIC ASSEMBLY

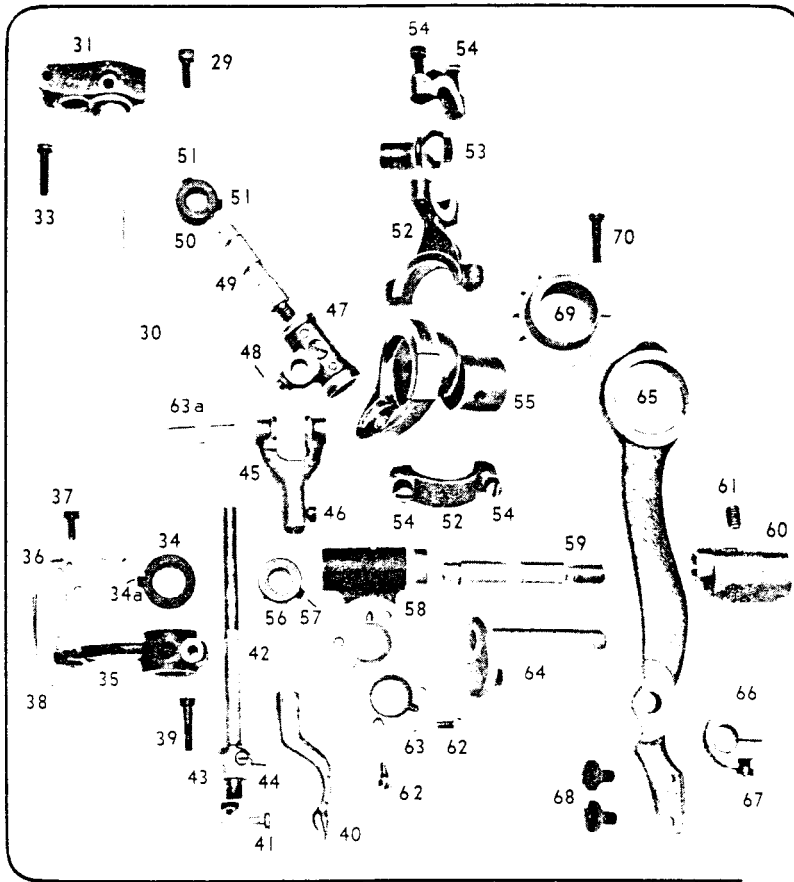

63a	400052	Looper Rod Fork Pin
64	400026	Feed Rocker
65	400024	Feed Lever
66	400027	Feed Rocker Clamp
67	400094	Feed Rocker Clamp Set Screw
68	400097	Feed Dog Fastening Screw (2)
69	400034	Needle Eccentric Ring
70	400094	Needle Eccentric Ring Clamping Screw

Illustrn. Ref. No.	Part No.	Description
	29	402072 Needle Shaft Crank Locking Screw
	30	400030 Needle Shaft
	31	400037 Needle Shaft Crank
	33	400094 Needle Shaft Crank Clamping Screw
	34	400084 Needle Shaft Collar 7/16"
	34a	400100 Needle Shaft Collar Set Screw
	35	400038 Needle Lever
	36	400039 Needle Lever Clamp
	37	400040 Needle Lever Clamp Screw
	38	400707 Needle (Size 2 1/2)
	39	400094 Needle Lever Clamping Screw
	40	400041 Looper
	41	400042 Looper Screw
	42	400043 Looper Rod
	43	400044 Looper Rod Ball
	44	400045 Looper Rod Ball Set Screw
	45	400051 Looper Fork
	46	400040 Looper Fork Clamping Screw
	47	400055 Looper Driving Stud Sleeve
	48	400099 Looper Driving Stud Sleeve Set Screw
	49	400053 Looper Driving Stud
	50	400054 Looper Driving Stud Collar
	51	400099 Looper Driving Stud Collar Set Screw
	52	400035 Needle Stitch Shaft Connection
	53	400036 Needle Stitch Shaft Connection Ball Stud
	54	400037 Needle Stitch Shaft Connection Fastening Screw (2)
	55	400320 Needle Stitch Eccentric (Regular)
	56	400049 Looper Rod Carrier Stud Collar
	57	400099 Looper Rod Carrier Stud Collar Set Screw
	58	400046 Looper Rod Carrier
	59	400048 Looper Rod Carrier Stud
	60	400050 Looper Adjusting Block
	61	400098 Looper Adjusting Block Set Screw
	62	400095 Looper Rod Carrier Cap Clamping Screw
	63	400047 Looper Rod Carrier Cap (2)

# B<sup>2</sup> PRESSER FOOT COMPLETE

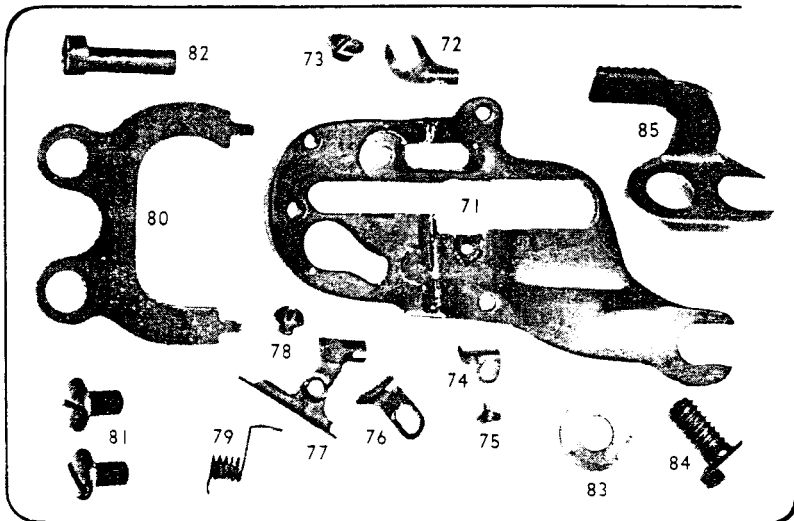

Illustrn. Ref. No.	Part No.	Description
	71	402157 Presserfoot Plate
	72	400081 Presserfoot Needle Guide
	73	400082 Presserfoot Needle Guide Screw
	74	401184 Presserfoot Metal Pin
	75	401185 Presserfoot Metal Pin Screw
	76	401200 Presserfoot Shoe Guide
	77	402400 Presserfoot Shoe (Only)
	78	401201 Presserfoot Shoe Guide Screw
	79	400065 Presserfoot Shoe Spring
	80	400060 Presserfoot Brace
	81	400096 Presserfoot Mounting Screw
	82	400066 Presserfoot Adjusting Eccentric Pin
	83	402068 Presserfoot Clamp Screw Washer
	84	400103 Presserfoot Clamp Screw
	85	400143 Feed Dog — Fine

# C FEED FRAME AND REGULATING DIAL ASSEMBLY

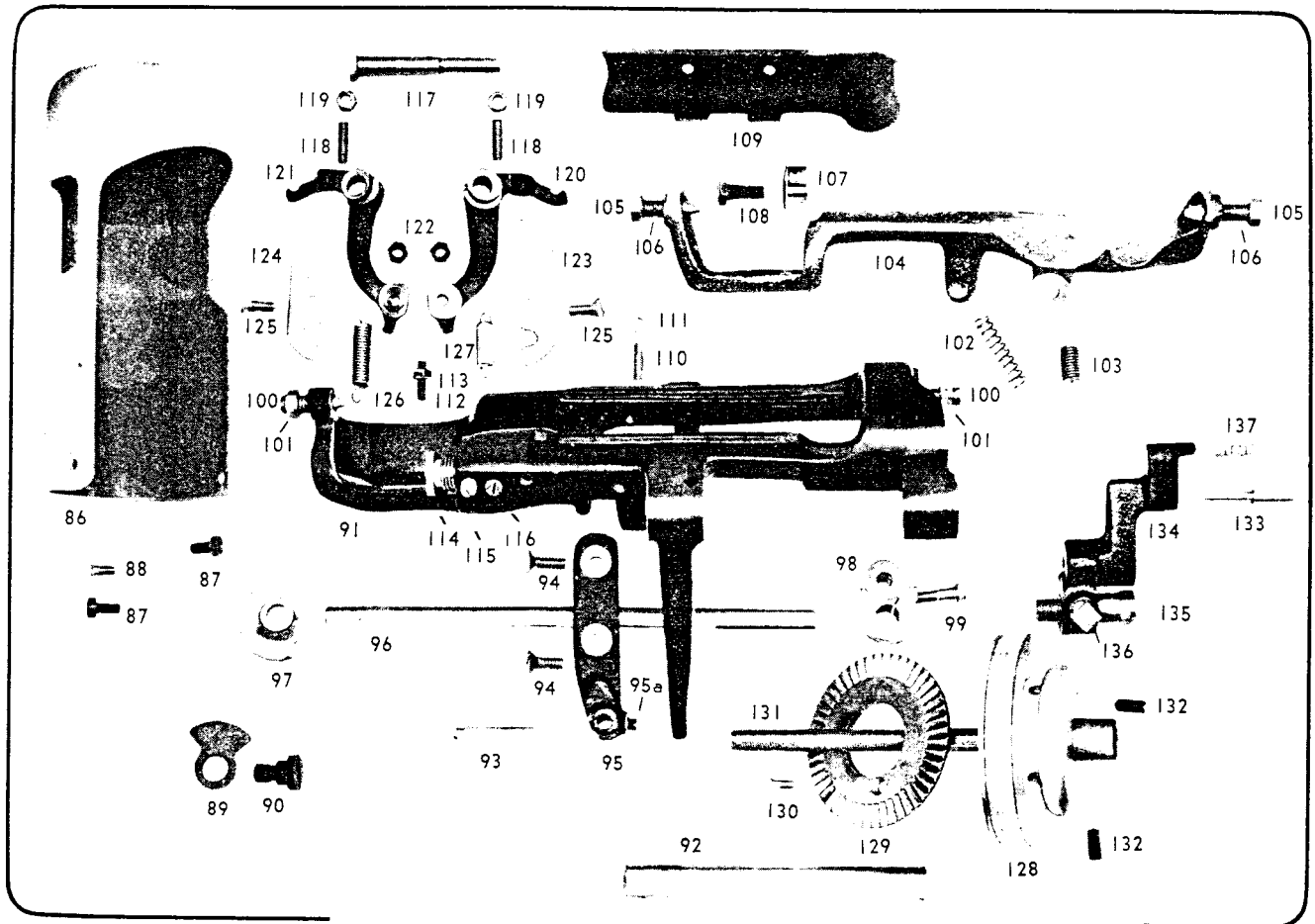

Illustrn. Ref. No.	Part No.	Description	Illustrn. Ref. No.	Part No.	Description
86	400206	Aluminum Sleeve (Long)	112	400020	Platen Bracket Limit Screw
87	400040	Aluminum Sleeve Mounting Screw (2)	113	400021	Platen Bracket Limit Screw Nut
88	402067	Aluminum Sleeve Positioning Screw	114	402073	Feed Bracket Stud Bushing
89	400310	Feed Frame Regulating Stop	115	400099	Feed Bracket Stud Bushing Set Screw
90	400010	Feed Frame Regulating Stop Stud	116	400100	Feed Bracket Stud Bushing Set Screw
91	400302	Feed Frame	117	400022	Feed Bracket Stud
92	400002	Feed Frame Hinge Pin	118	400020	Feed Bracket Limit Screw (2)
93	400385	Feed Frame Extension Spring Bracket Pin	119	400021	Feed Bracket Limit Screw Nut (2)
94	400384	Feed Frame Extension Spring Bracket Screw	120	400017	Feed Platen Bracket Right
95	400383	Feed Frame Extension Spring Bracket	121	400018	Feed Platen Bracket Left
95a	400099	Feed Frame Extension Spring Bracket Pin Lock Screw	122	400102	Feed Platen Screw Nut (2)
96	400069	Rib Shaft	123	400015	Feed Platen Right
97	400336	Rib (Skip)	124	400016	Feed Platen Left
98	400071	Rib Shaft Crank	125	400101	Feed Platen Screw (2)
99	400094	Rib Shaft Crank Fastening Screw	126	400365	Feed Platen Spring Right
100	400075	Rib Shaft Center Screw (2)	127	400019	Feed Platen Spring Left
101	400076	Rib Shaft Center Screw Nut (2)	128	400195	Regulating Dial
102	400149	Rib Shaft Cradle Spring	129	400196	Regulating Dial Ratchet
103	400013	Rib Shaft Cradle Positioning Screw	130	400197	Regulating Dial Ratchet Set Screw
104	400333	Rib Shaft Cradle Styles No. 2	131	400205	Regulating Dial Regulating Screw
105	400076	Rib Shaft Cradle Center Screw Nut (2)	132	402051	Regulating Dial Set Screw (2)
106	400075	Rib Shaft Cradle Center Screw (2)	133	400202	Regulating Dial Plunger
107	400640	Rib Shaft Support	134	400200	Regulating Dial Indicating Arrow Bracket
108	400074	Rib Shaft Support Screw	135	400203	Regulating Dial Indicating Arrow Bracket Screw
109	400070	Rib Shaft Cover Complete	136	400205	Regulating Dial Indicating Screw
110	400334	Rib Shaft Cradle Screw	137	400201	Regulating Dial Plunger Spring
111	400312	Rib Shaft Cradle Screw Nut			

# D SWING PLATE AND KNEE LIFT ASSEMBLY

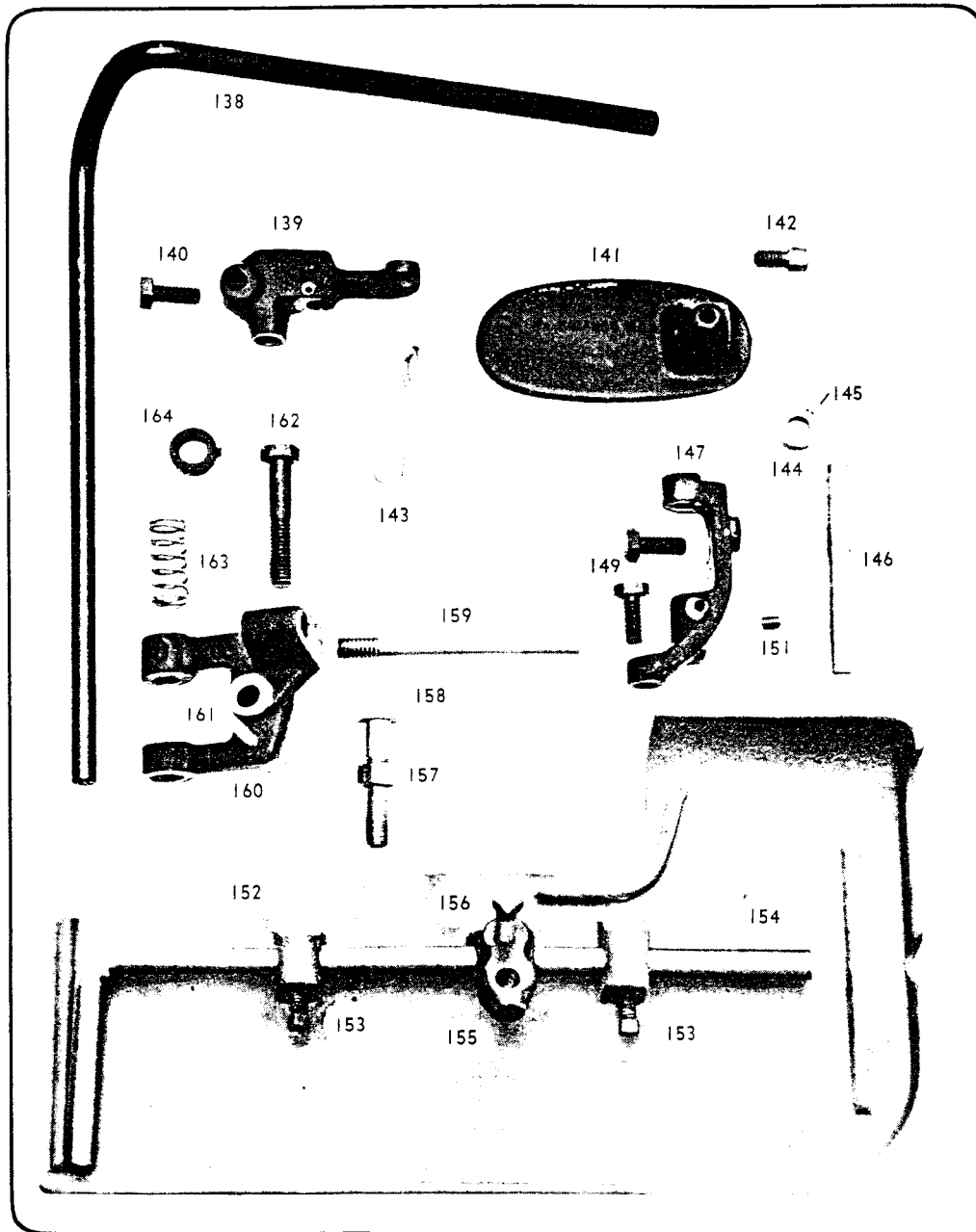

Illustrn. Ref. No.	Part No.	Description	Illustrn. Ref. No.	Part No.	Description		
	138	400416	Knee Lift Rod		152	402465	Swing Plate
	139	400418	Knee Lift Rod Clamp		153	400182	Swing Plate Clamp Screw (2)
	140	400419	Knee Lift Rod Clamp Screw		154	400187	Swing Plate Rod
	141	400417	Knee Lift Pad		155	400193	Swing Plate Stop Stud Bracket
	142	402079	Knee Lift Pad Set Screw		156	400386	Swing Plate Stop Stud Bracket Screw
	143	400408	Knee Lift Connecting Hook		157	400192	Swing Plate Stop Stud Nut
	144	400415	Knee Lift Collar		158	400191	Swing Plate Stop Stud
	145	400100	Knee Lift Collar Set Screw		159	400184	Swing Plate Main Bracket Stud
	146	400414	Knee Lift Short Shaft		160	400183	Swing Plate Main Bracket
	147	400412	Knee Lift Main Bracket		161	400185	Swing Plate Main Bracket Pin
	149	400413	Knee Lift Main Bracket Screw (2)		162	400186	Swing Plate Main Bracket Screw
	151	400098	Knee Lift Main Bracket Set Screw		163	400190	Swing Plate Rod Spring
					164	400188	Swing Plate Rod Collar

# E SKIP CONTROL AND CRANK ASSEMBLY

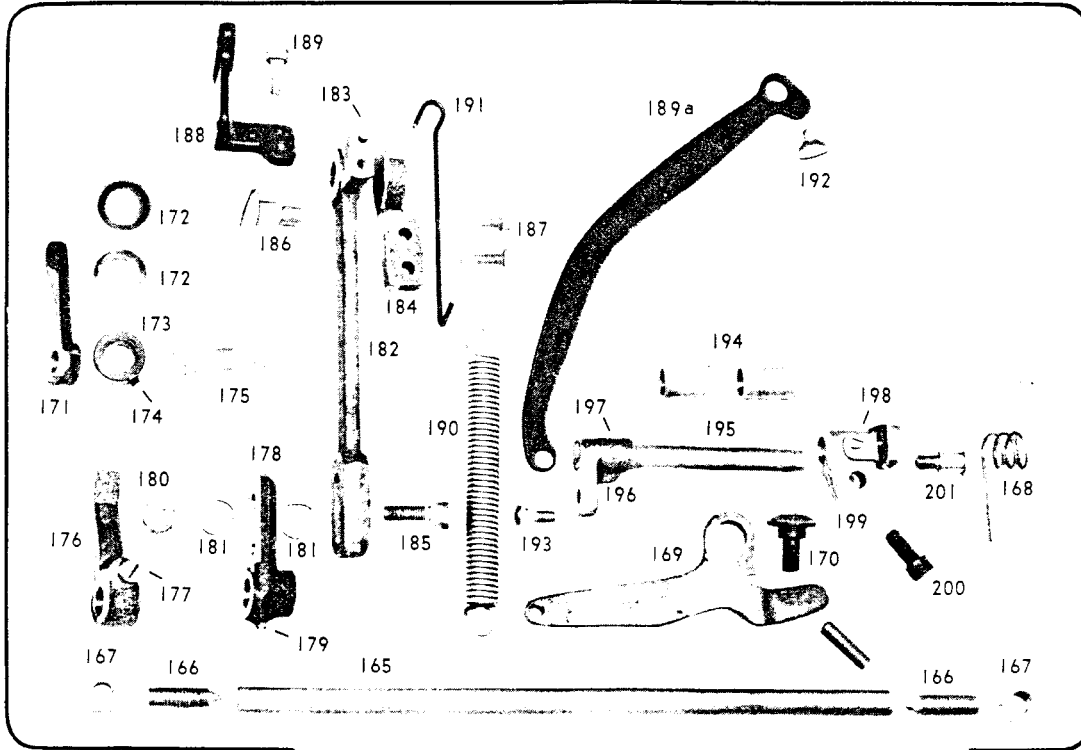

Illustrn. Ref. No.	Part No.	Description	Illustrn. Ref. No.	Part No.	Description
	165	400360 Skip Control Cam Shaft		184	400377 Skip Control Main Lever Bracket
	166	400361 Skip Control Cam Shaft Center Screw (2)		185	400368 Skip Control Cam Shaft Crank Stud
	167	400362 Skip Control Cam Shaft Center Screw Nut (2)		186	400376 Skip Control Main Lever Stud
	168	400365 Cam Lever Spring		187	402053 Skip Control Main Lever Bracket Mounting Screw (2)
	169	400309 Feed Frame Tension Spring Lever		188	400380 Skip Control Main Lever Extension
	170	400005 Feed Frame Tension Spring Lever Stud		189	400381 Skip Control Main Lever Extension Fastening Screw
	171	400371 Skip Control Hand Lever		189a	400339 Rib Shaft Connection Lever
	172	400372 Skip Control Hand Lever Washer (2)		190	400003 Feed Frame Tension Spring (Short)
	173	402373 Skip Control Throw Out Collar		191	400307 Feed Frame Tension Spring Hook
	174	400099 Skip Control Throw Out Collar Set Screw		192	400078 Rib Shaft Connection Lever Stud
	175	402405 Skip Control Throw Out Shaft		193	400072 Rib Shaft Crank Stud
	176	400378 Skip Control Throw Out Lever		194	402468 Rib Rocker Crank Shaft Bearing (2)
	177	402053 Skip Control Throw Out Fastening Screw		195	400346 Rib Rocker Crank Shaft
	178	400366 Skip Control Cam Shaft Crank		196	400349 Rib Rocker Crank Left
	179	400099 Skip Control Cam Shaft Crank Set Screw		197	400367 Rib Rocker Crank Left Tapered Pin
	180	400370 Skip Control Cam Shaft Stud Nut		198	400099 Rib Rocker Crank Set Screw
	181	400369 Skip Control Cam Shaft Stud Washer (2)		199	400348 Rib Rocker Crank Right
	182	400379 Skip Control Main Lever		200	400301 Rib Rocker Crank Right Fastening Screw
	183	400382 Skip Control Main Lever Pin		201	400080 Main Shaft Connection Lever Stud

## ACCESSORIES



402063 Washer

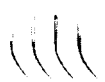

Needles  
(Specify Size)



402406 Clamping Bolt

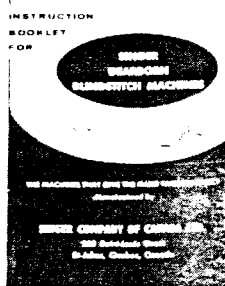

400120 Cotton Stand



402184 Instruction Booklet

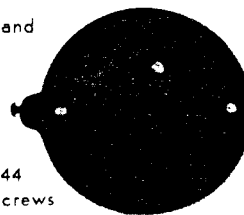

402044 Wood Screws

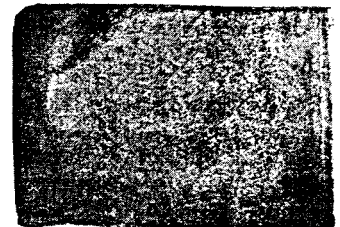

402086 Cotton Bag

# F MACHINE HEAD

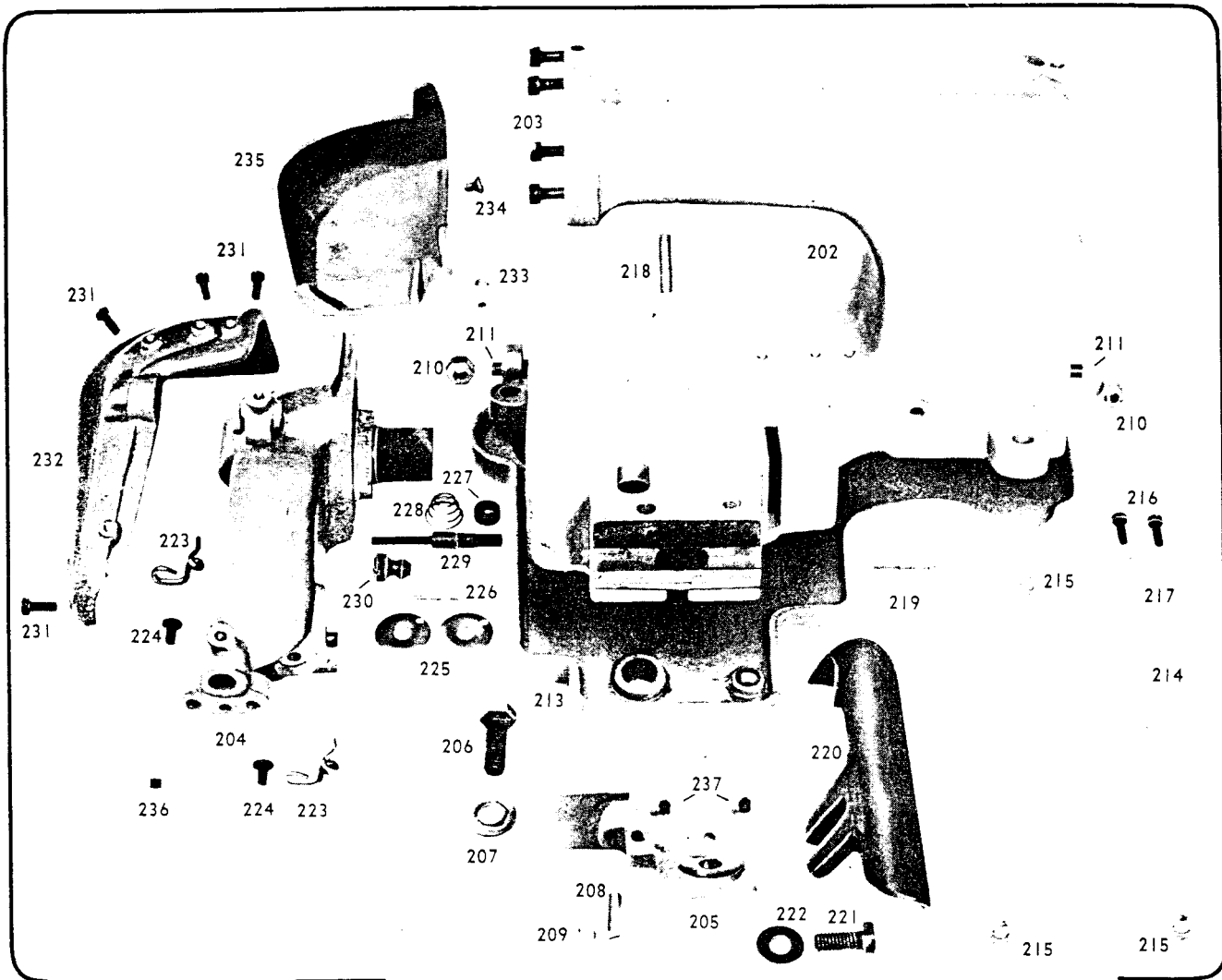

Illustrn. Ref. No.	Part No.	Description	Illustrn. Ref. No.	Part No.	Description
202	402427	Main Frame (Skip)	221	400419	Belt Guard Fastening Screw
203	400301	Main Frame Head Screw (4)	222	402063	Belt Guard Fastening Screw Washer
204	401197	Main Frame Head	223	400083	Thread Guide (2)
205	400305	Feed Frame Bracket (Skip)	224	400096	Thread Guide Mounting Screw (2)
206	400306	Feed Frame Bracket Screw	225	400088	Tension Disc (2)
207	402431	Feed Frame Bracket Screw Washer	226	400093	Tension Pin
208	400311	Feed Frame Safety Limit Screw	227	400092	Tension Regulating Nut
209	400312	Feed Frame Safety Limit Screw Nut (2)	228	400091	Tension Spring
210	400362	Base Plate Center Screw Nut (2)	229	400090	Tension Long Stud
211	400361	Base Plate Center Screw (2)	230	400087	Upper Cover Fastening Thumb Nut
213	400863	Base Plate	231	400598	Oil Cup (4)
214	400351	Back Plate	232	400105	Upper Cover
215	402401	Back Plate Screw (3)	233	402052	Lower Cover Mounting Screw
216	402426	Main Frame Oil Fitting (2)	234	402407	Lower Cover Mounting Screw
217	400125	Main Shaft Oil Cup No. 202 (2)	235	400104	Lower Cover
218	400311	Main Spring Hook Safety Limit Screw	236	400099	Main Spring Hook Safety Limit Lock Screw
219	400014	Feed Frame Stop Screw and Nut	237	400099	Feed Frame Hinge Pin Set Screw (2)
220	400352	Belt Guard			

From the library of: Diamond Needle Corp

WHEN ORDERING: Specify Machine Model, Quantity of each item required, Singer Code Number, Serial Number of Machine.

**S** SINGER  
DEARBORN BLIND  
STITCH MACHINE